

# Vulcan

## Datasheet





# Vulcan

## An Autonomous Cleaning Robot

Step into the world of modernized heavy-duty cleaning with Vulcan, our remarkable Autonomous Floor Cleaning Robot. Vulcan represents the epitome of innovative cleanliness solutions, offering a paradigm shift in the way we approach cleaning tasks across a myriad of settings. Vulcan seamlessly integrates with your daily operations, enhancing cleaning efficiency like never before.

Vulcan combines cutting-edge technology with a sleek and efficient design, providing an array of benefits that redefine cleanliness and hygiene. From efficiently sweeping through commercial offices to ensuring spotless conditions in hospitals, Vulcan's capabilities span across multiple industries. No more laborious, manual cleaning – Vulcan is the smart, proactive solution that elevates the standard of cleanliness.

## Key Features

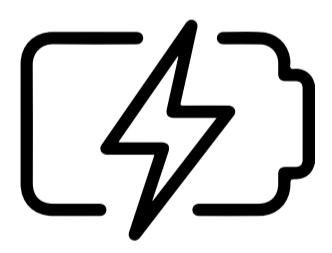

Automatic Fill, Purge & Charge

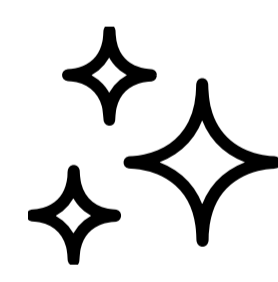

High Efficiency Cleaning

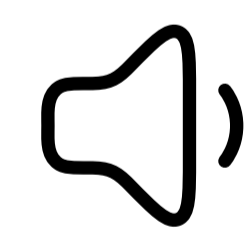

Low Noise Mode

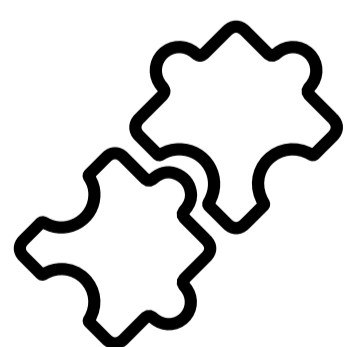

Easy Assembly & Disassembly

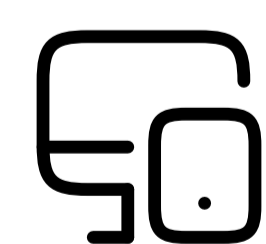

Digital Management

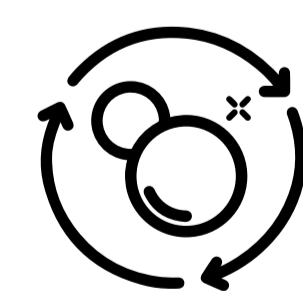

Autonomous Cleaning



## Physical Specifications

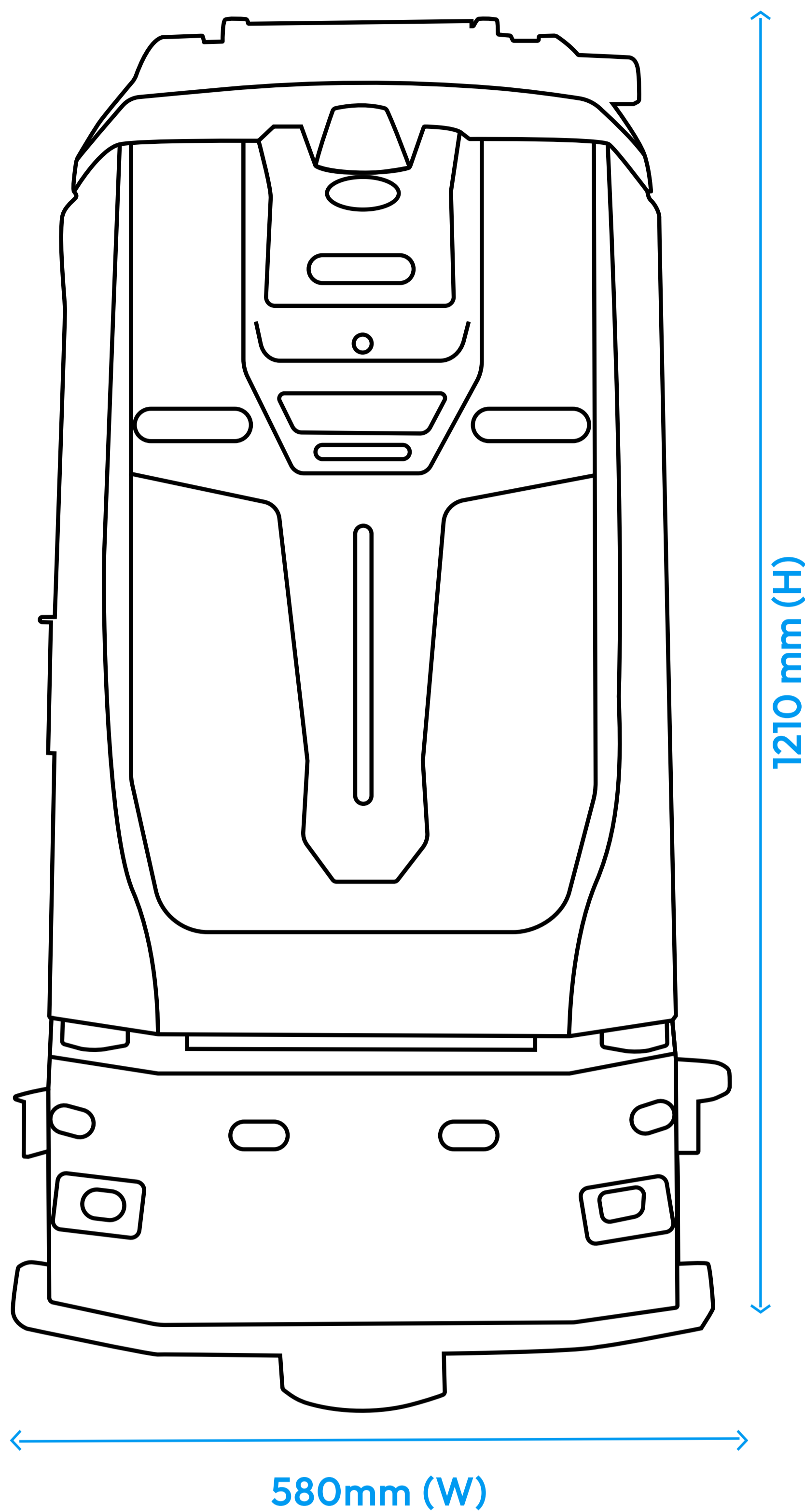

<b>Color</b>	Black
<b>Weight</b>	254 kg
<b>Scrub Deck Width</b>	510mm
<b>Suction rack width</b>	790mm
<b>Clean water tank volume</b>	70L
<b>Sewage tank volume</b>	50L

## Power and Battery Systems

Vulcan takes the hassle out of maintaining your equipment. It automatically handles filling, purging, and charging processes, ensuring your cleaning operations run smoothly. Say goodbye to manual interventions and hello to increased cleaning efficiency.

<b>Battery Type</b>	Lead Acid / Lithium-Ion
<b>Battery Life</b>	4 hours / 3.5 hours
<b>Battery Voltage</b>	DC24V / 25.6V
<b>Battery Capacity</b>	120Ah / 100 Ah
<b>Overcurrent Protection</b>	Yes
<b>Intelligent Power Management</b>	Yes
<b>Power Button</b>	Yes

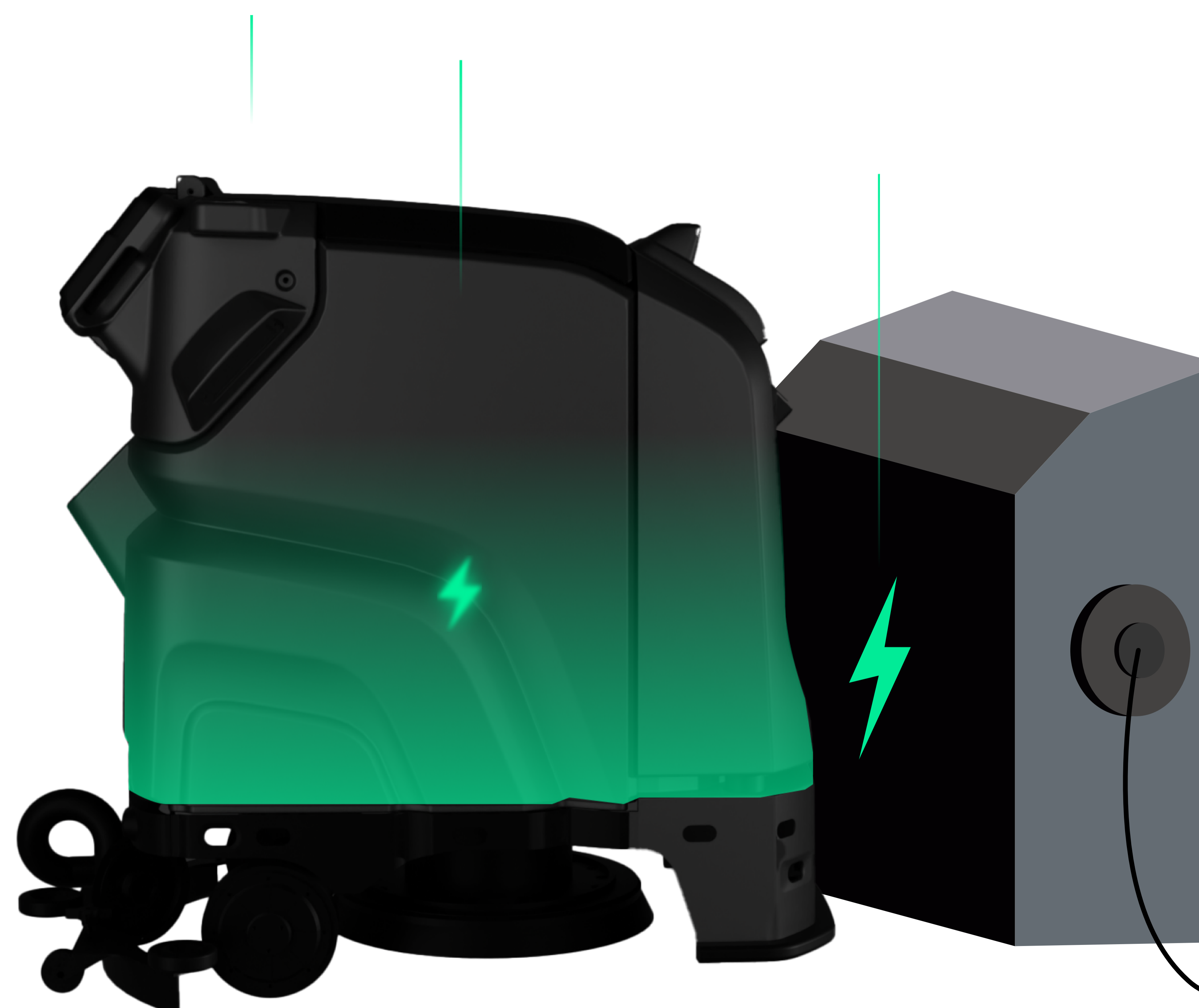





## Performance Specifications

Vulcan is the ultimate heavy-duty industrial cleaning robot. Designed to withstand tough conditions, it excels in demanding environments.

Whether dealing with stubborn debris or challenging surfaces, Vulcan's powerful suction and advanced technology guarantee top-notch performance.

Specification	Lead-acid battery	Lithium battery
Ground pressure	27kg	27kg
Pressure Per Unit Area	13.2g/cm <sup>2</sup>	13.2g/cm <sup>2</sup>
Speed	4km/h	4km/h
Work Efficiency	2040m <sup>2</sup> /h	2040m <sup>2</sup> /h
Gradeability	6%	6%
Working Hours	4h	3.5h
Navigation Scheme	Vision + Laser	Vision + Laser

### Disclaimer:

We reserve the right to make technical changes to the products and changes to the contents of this document at any time without any prior notice. For orders, the respective agreed properties are decisive. Kody Robots assumes no responsibility for any errors or omissions in this document. We reserve all the rights to this document and the objects and illustrations contained herein. Reproduction, disclosure to third parties or exploitation of its contents even in part is prohibited without the prior written consent of Kody Robots.

☎ +91 93167 56367

🌐 [www.kodyrobots.com](http://www.kodyrobots.com)

✉ [sales@kodytechnolab.com](mailto:sales@kodytechnolab.com)