

Dasher

Datasheet





Dasher

A Smart Delivery Companion

Welcome to the world of innovation and automation with Kody Robots!

Dasher is not just a robot; it's your charming delivery companion, designed to revolutionize your operations & enhance customer experiences. Dasher's adorable bionic design and cutting-edge technology combine to offer an array of benefits, ensuring efficient in-house delivery service that keeps food piping hot and mail delivered on time.

Dasher becomes a part of your business, streamlining operations like never before. Whether you're in the restaurant industry or managing office spaces, Dasher is here to exceed your expectations.

Key Features

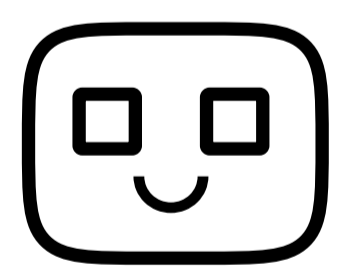

Smart Expression

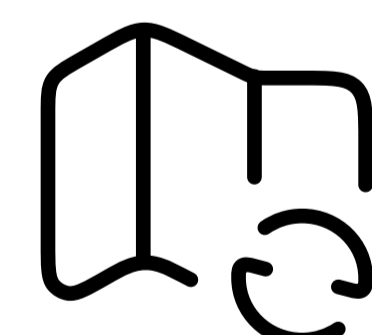

Autonomous Navigation



Supporting Voice Control

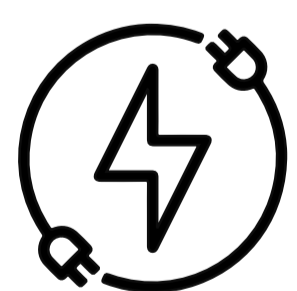

Automated Charging

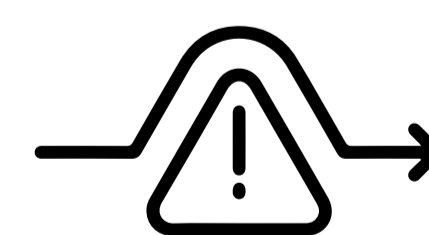

Smart Obstacle Avoidance

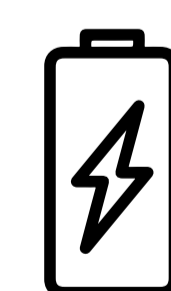

10+ Hour of Battery Power

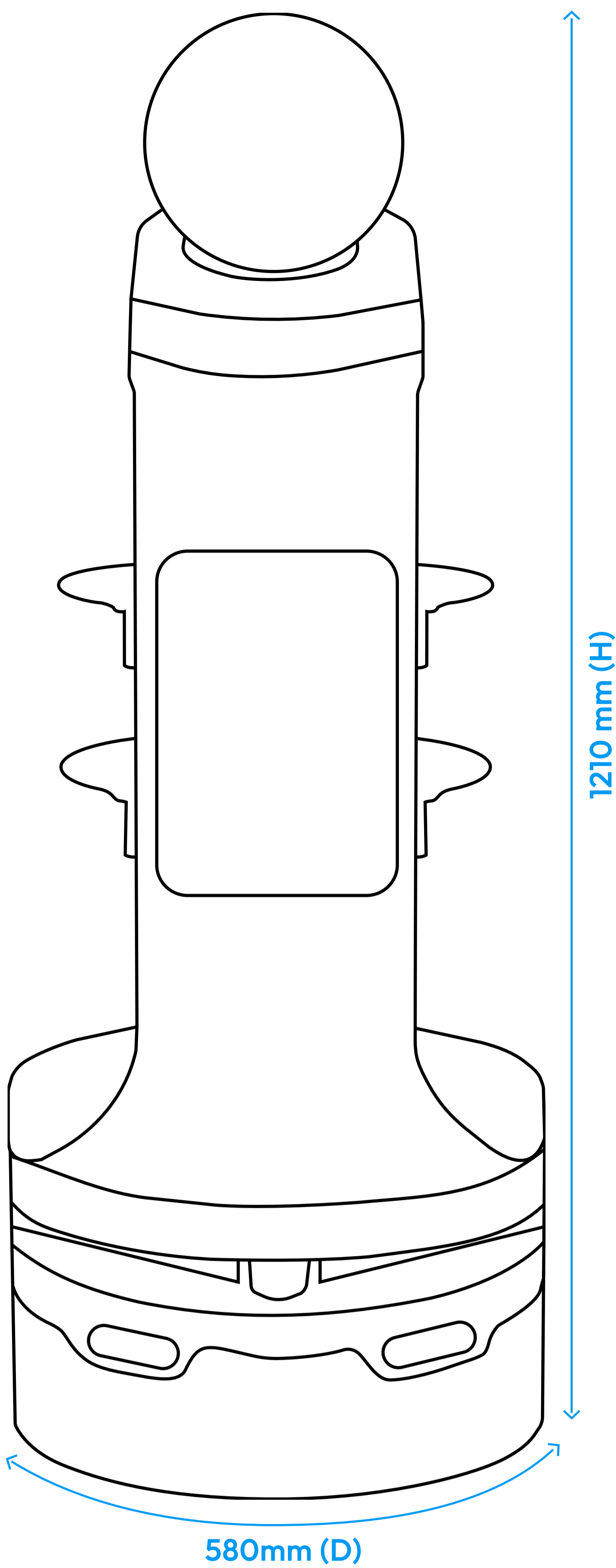

Physical Specifications

Color	Black, White
Weight	48.5 kg
Chassis	3mm, 4mm Mild Steel
Suspension	Aluminum
Support Frame	2mm Mild Steel
Body	Thermoplastic

Power and Battery Systems

The robot's advanced Battery Management System ensures that Dasher automatically returns to the charging station for recharging. Additionally, the charging station's default power-off feature enhances safety by activating power only during the robot's recharging process, preventing unexpected situations.

Battery Type	Lithium-Ion 25.6V/20Ah
Battery Life	10+ Hours
Power Adapter	Input: AC110-240V, 50/60Hz, Output: DC25.6V 7A
Overcurrent Protection	Yes
Intelligent Power Management	Yes
Power Button	Yes

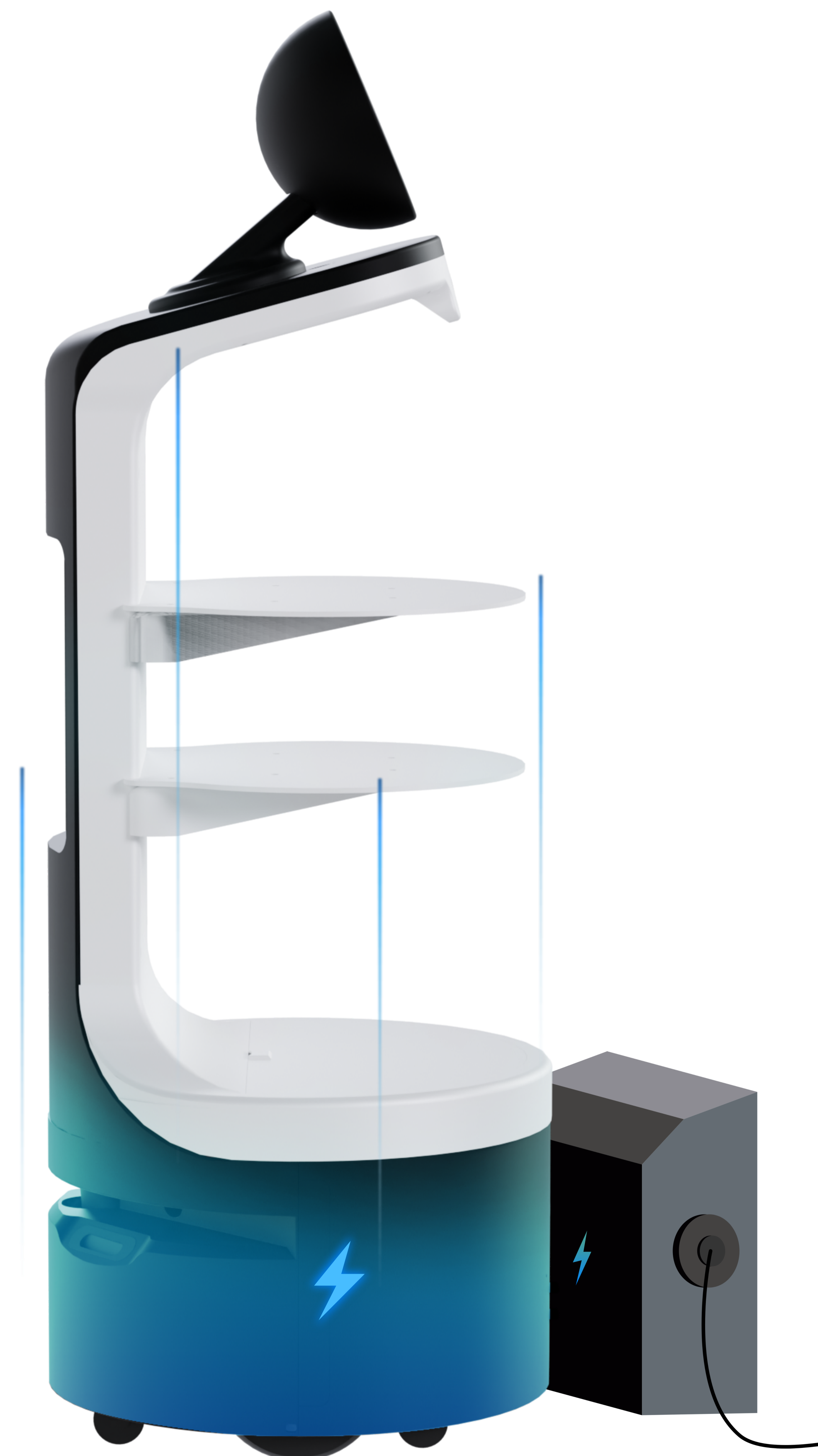

Vision & Mobility System

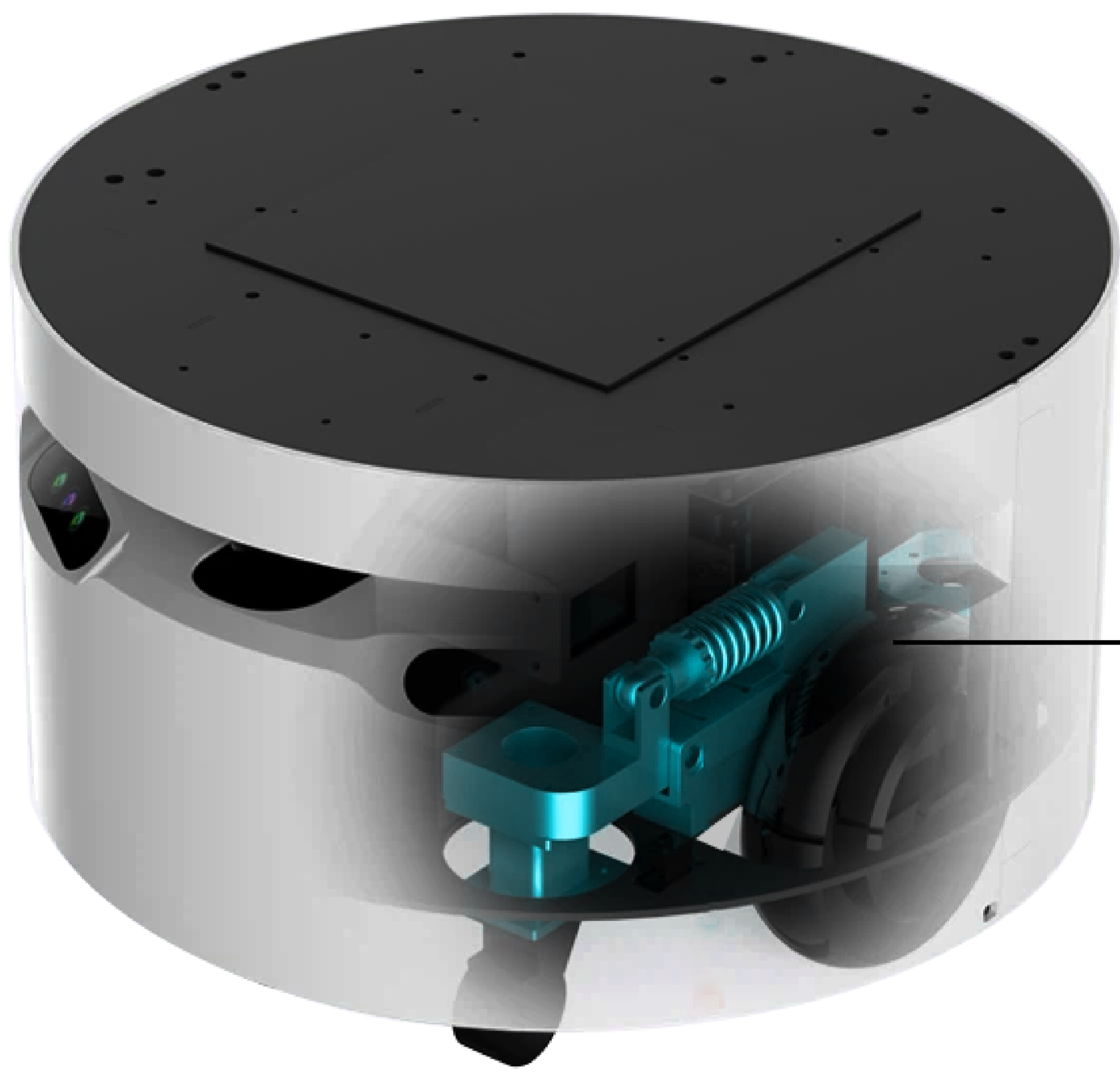

• Independent Suspension System

Dasher's Independent Suspension System ensures stability and precision, allowing it to navigate various terrains with ease.

Navigation

Motor Driven

6.5-inch Hub Motor

Gyro

Single axis high precision attitude sensor

Mapping & Navigation

Dual SLAM Technology

Max Speed

Up to 5 mph

LIDAR Sensors

Type

Single line lidar

Wavelength

905nm

Working area

270 degrees

Range

25 mtrs

Camera

Type

Dual Depth Camera System

Resolution

Up to 1280 x 720

Frame rate

90 fps

Range

Up to 10 mts

Pixel resolution

2 MP, RGB sensor

Button

Emergency Button

Yes

One Touch Button

Yes



Display Specification

Dasher features two display screens to enhance interaction and control. Face Display is for real-time telemetry and diagnostics and Body Display is for messaging and promotions.

Screen Type Capacitive Touch Screen

Face Display

Screen Size 7 Inches

Resolution 1024 x 600 Pixels

Touch Sensitivity Yes

Body Display

Screen Size 12.1 Inches

Resolution 1200 x 800 Pixels

Touch Sensitivity Yes

Other Technical Specifications:

Processing System

CPU	Quad-core Cortex-A7, up to 1.2GHz
OS	Android
Hard Disk	256GB High-Speed SSD
Memory	16GB RAM
Built-in clock	RTC

Navigation System

CPU	Intel® Core™ i5 Processor
OS	Linux
Hard Disk	32GB High-Speed SSD

Other Specifications

Wi-Fi Support	Dual-Band (2.4GHz & 5GHz)
External I/O Port	Micro USB 2.0 RJ45 Network Port HOST*3

The Dasher Control System

Effortlessly manage Dasher and your Operations

The Dasher control system simplifies and optimizes the management of Dasher and your operations. It is a comprehensive system that ensures efficient and hassle-free in-house deliveries, whether you run a restaurant or office space.

The control system provides with an intuitive dashboard for streamlined supervision, real-time monitoring for on-the-spot delivery oversight, and menu customization to cater perfectly to your customer's preferences.

Managing your employees and inventory becomes a breeze, and you can access detailed analytics to make data-driven decisions. Elevate the overall dining or working experience by offering effortless, secure ordering, quick reordering, service requests, real-time order tracking, and timely notifications.

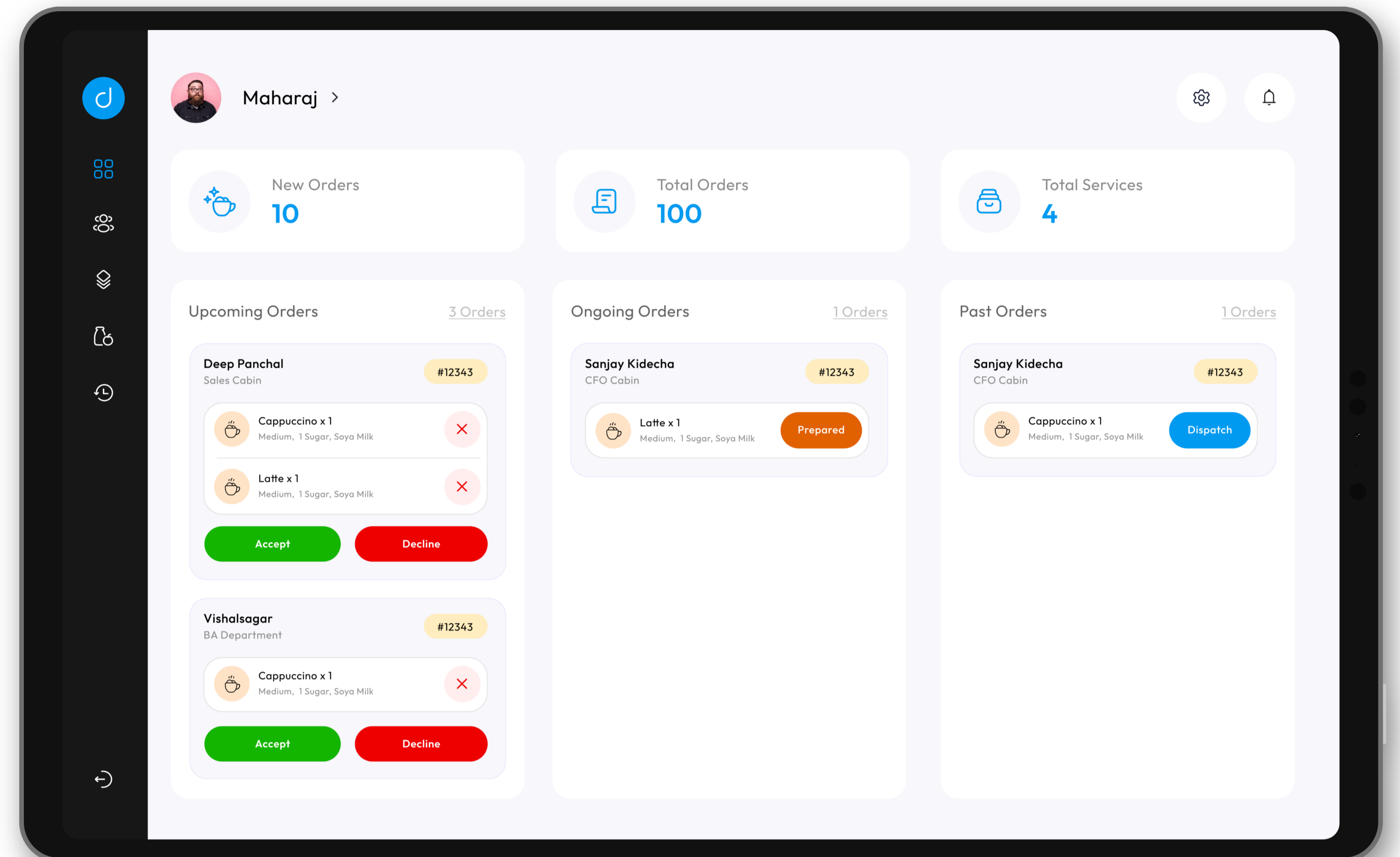

- ✓ Intuitive Dashboard
- ✓ Real Time Monitoring
- ✓ Menu Customization

- ✓ Employee Management
- ✓ Inventory Control
- ✓ Detailed Analytics

Disclaimer:

We reserve the right to make technical changes to the products and changes to the contents of this document at any time without any prior notice. For orders, the respective agreed properties are decisive. Kody Robots assumes no responsibility for any errors or omissions in this document. We reserve all the rights to this document and the objects and illustrations contained herein. Reproduction, disclosure to third parties or exploitation of its contents even in part is prohibited without the prior written consent of Kody Robots.

☎ +91 93167 56367

🌐 www.kodyrobots.com

✉ sales@kodytechnolab.com